

2VS+DBOX KOKOAMISOHJE

valitse käteisyys, vaihtamalla sohvan ja vuodevaatelaatikon paikkaa

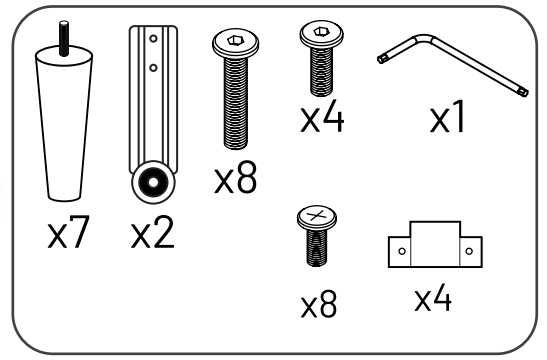

① Käsinöjien kiinnitys

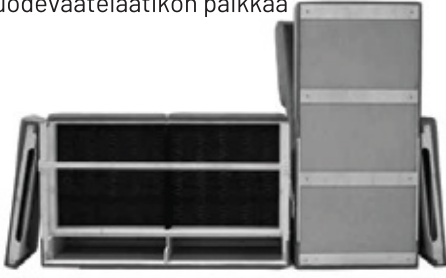
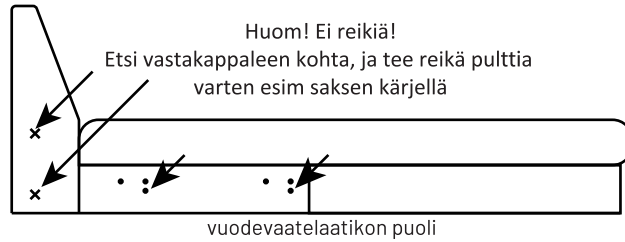
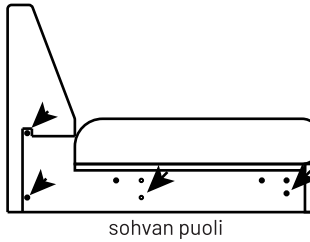
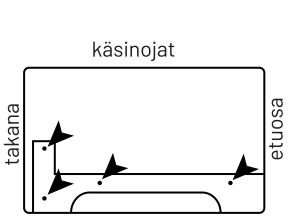
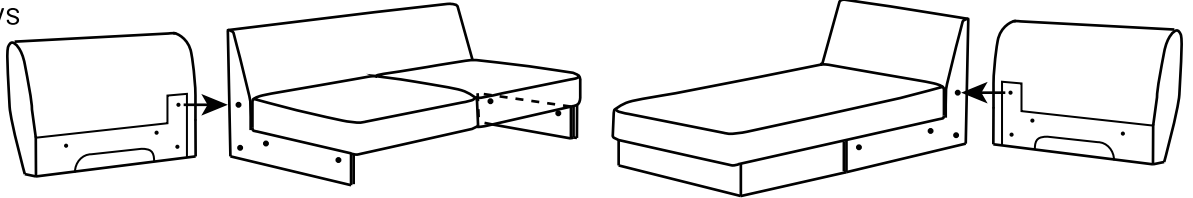
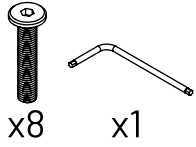

② Kiinnittimet

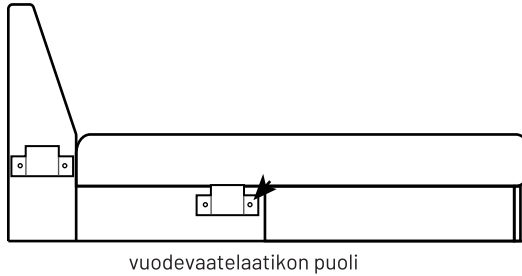
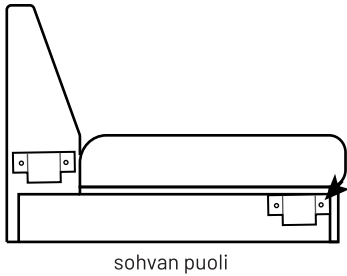
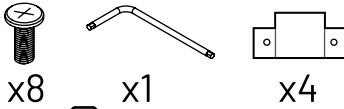

③ pyörät vuodeosaan 16mm pultilla

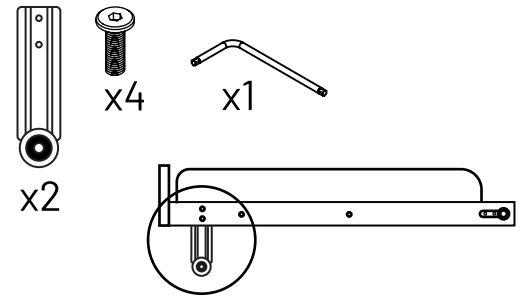

④ jalkojen paikat

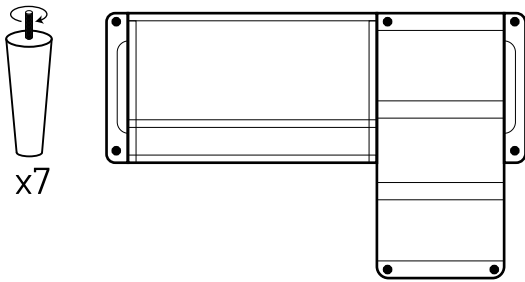

⑤

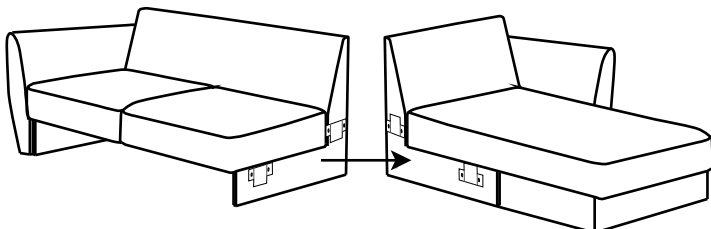

⑥ laita yhteen

työnnä mekanismi takaisin paikoilleen, nostamalla takaosasta koukkujen yli ja testaa mekanismin toimivuus

