

# NEVADA - modular sofa - OPENCORNER

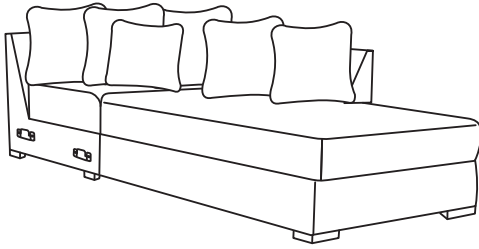

A	Wood	Plastic <sup>281</sup>	3 pcs.
B	Wood	Plastic 2pcs.	3 pcs.
C			9 pcs.
D			9 pcs.

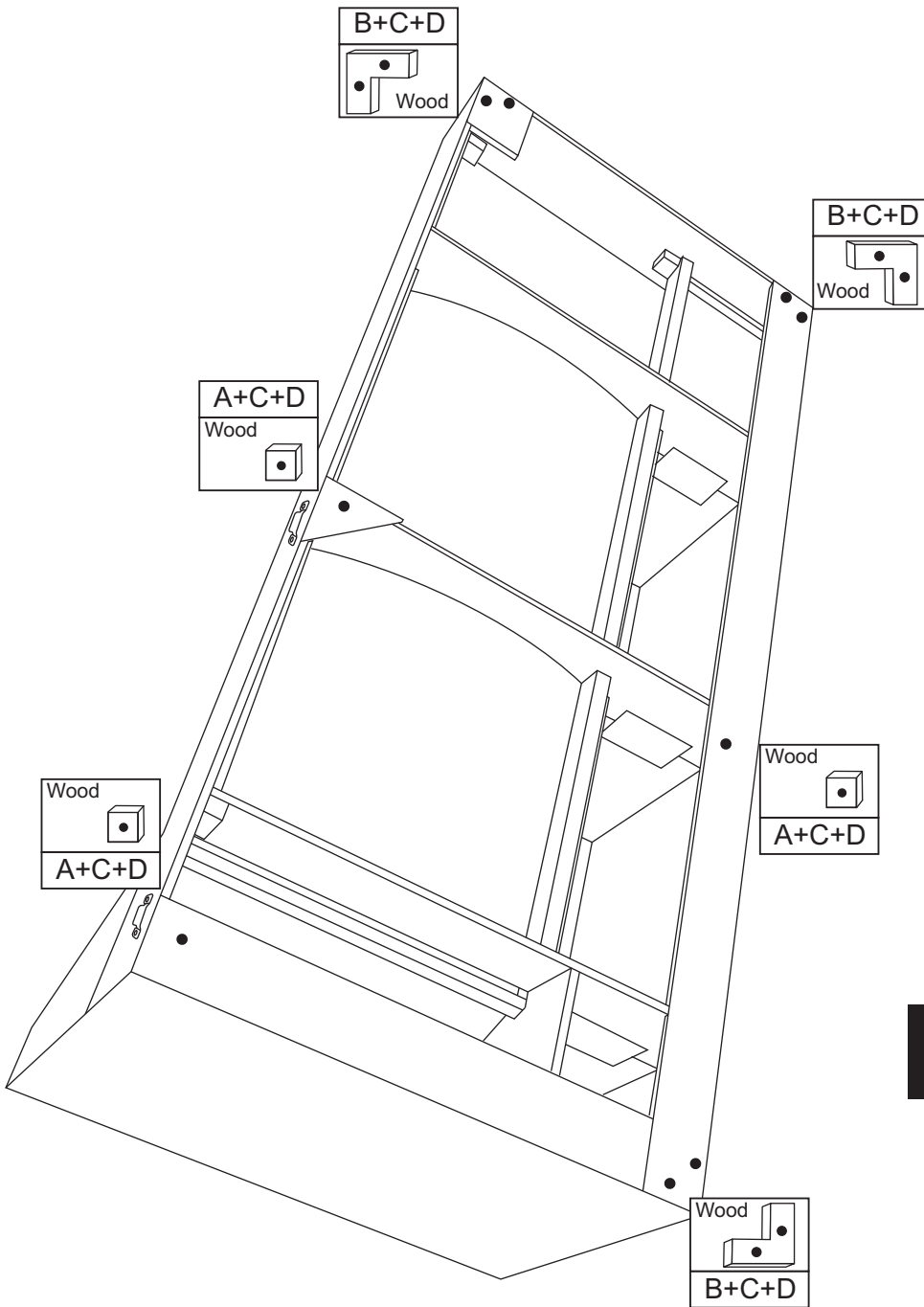

**I**

Attach parts of legs.

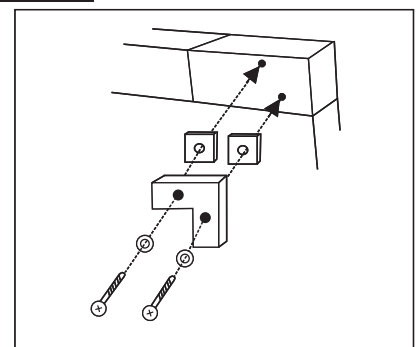

**IMPORTANT** Package with legs is attached at the bottom of the sofa.

# Modular sofa - SEATER + ARMREST

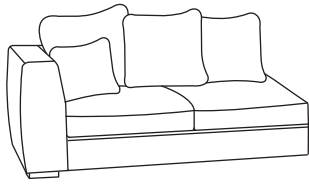

2,5 seater + armrest

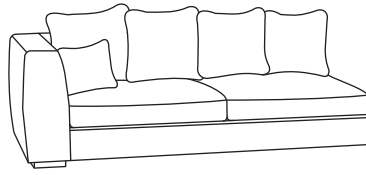

3 seater + armrest



NEVADA 1



NEVADA 2

A	Wood Plastic 2pcs.	2 pcs.
B	Plastic	4 pcs.
C	Screw	4 pcs.

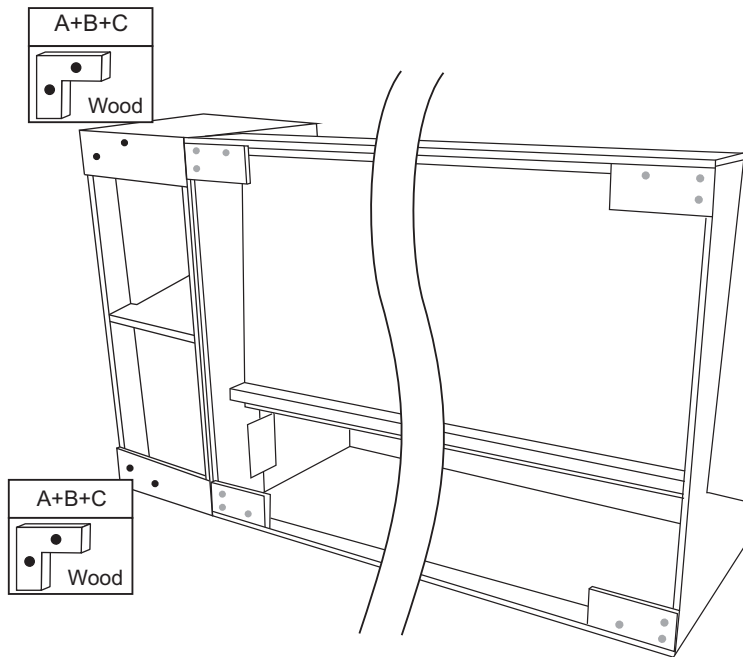

## I

Attach parts of legs.

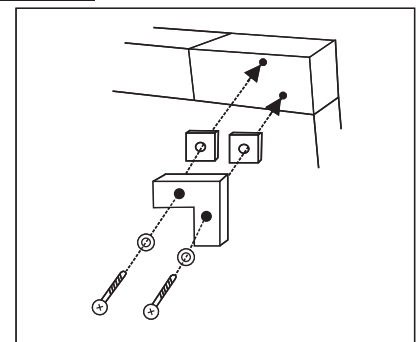

**IMPORTANT** Package with legs is attached at the bottom of the sofa.